

ALTID DE BEDSTE
BESKYTTELSVÆRN





GLOBAL SAFEZONE ApS PRÆSENTERER NYE PRODUKTER

 **REFLEX**
RESISTANT AND FLEXIBLE



Indhold



side 02

| | | | | | |
|----|-----------------|---------|----|-------------------|---------|
| 01 | Reolbeskyttelse | side 08 | 06 | Link | side 38 |
| 02 | Pullerter | side 16 | 07 | Søjlebeskyttelse | side 46 |
| 03 | Påkørselsværn | side 20 | 08 | Hjørnebeskyttelse | side 52 |
| 04 | Fodgængerværn | side 26 | 09 | Bundliste | side 54 |
| 05 | Låger | side 32 | 10 | Vægbeskyttelse | side 58 |
| | | | 11 | PVC Paneler | side 64 |

VORES **PENDUL** TIL TEST AF STYRKE



VI HAR FORNYLIGT BESTÅET **PÅKØRSELSTEST** PÅ DISSE PRODUKTER
TAKKET VÆRE DET NYE REFLEX MATERIALE



REOLBESKYTTELSE

I HENHOLD TIL DIN EN 15512:2010-09

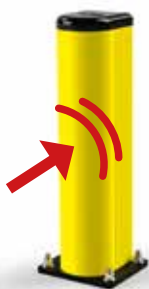

PULLERT GRD 150

I HENHOLD TIL DGUV Regel 108-007

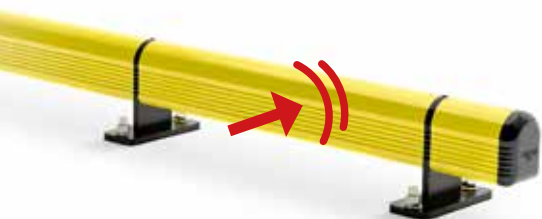





PÅKØRSELSVÆRN GRIN 150

I HENHOLD TIL AFNORNP P98-310

...OG VI ARBEJDER FORTLØBENDE PÅ AT FORBEDRE VORES PRODUKTER...

VI ER VERDENS **BEDSTE PRODUCENT** AF VINYL
FLEKSIBLE VÆRN

BEDSTE MATERIALEVALG I FHT STÅL, BETON ELLER ANDRE POLYMER MATERIALER

| | <u>Global SafeZone ApS</u> | <u>METAL</u> | <u>PE/PP</u> | <u>TRÆ</u> |
|----------------|---|---|---|---|
| |  |  |  |  |
| NEM RENGØRING | ● ● ● ● ● | ● ● ● ● ○ | ● ● ○ ○ ○ | ○ ○ ○ ○ ○ |
| RIDSER | ● ● ● ● ● | ● ● ● ○ ○ | ● ● ● ○ ○ | ● ○ ○ ○ ○ |
| FLEKSIBILITET | ● ● ● ● ● | ● ○ ○ ○ ○ | ● ● ● ● ● | ● ● ○ ○ ○ |
| STØDDÆMPNING | ● ● ● ● ● | ○ ○ ○ ○ ○ | ● ● ● ● ○ | ● ● ○ ○ ○ |
| HURTIG MONTAGE | ● ● ● ● ● | ● ● ● ● ● | ● ● ● ○ ○ | ● ● ● ● ○ |
| PLADSBEVARENDE | ● ● ● ● ○ | ● ● ● ● ● | ● ● ○ ○ ○ | ● ● ● ○ ○ |
| BRANDSIKKER | ● ● ● ● ○ | ● ● ● ● ● | ○ ○ ○ ○ ○ | ○ ○ ○ ○ ○ |
| LANG LEVETID | ● ● ● ● ● | ● ● ● ● ● | ● ● ● ○ ○ | ● ● ○ ○ ○ |

FORSKNING OG UDVIKLING KUNDETILPASSET PROJEKTSTYRING

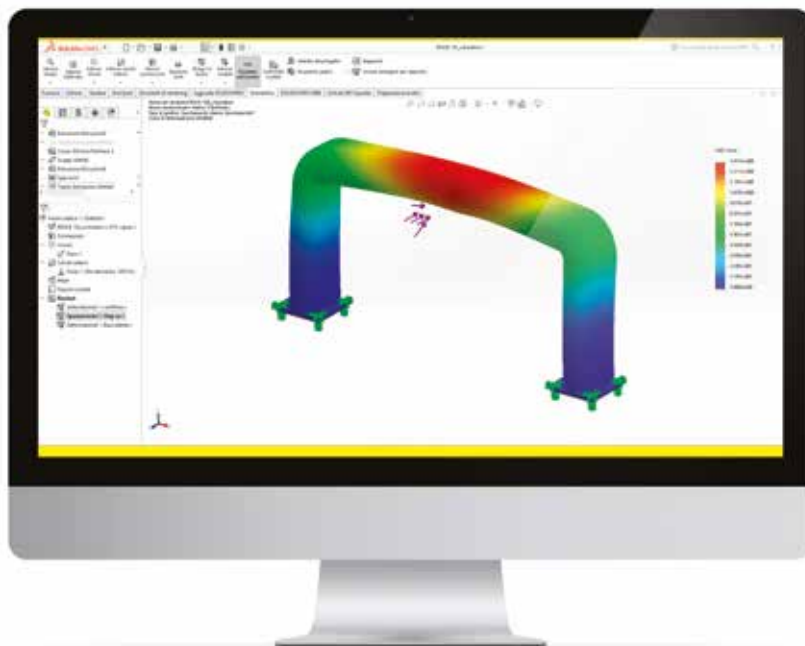

NYHEDER!

**GØR
DET SELV!**

GENIUS

DEN LÆNGDE DU ØNSKER



UNIKT SYSTEM I VERDEN!

TILPAS LÆNGDEN TIL DIT BEHOV!

TILGÆNGELIG TIL TO STØRRELSER.

SKÆR OG BOR MED **GENIUS** 



VÆRSGOD, DIN KUNDETILPASSEDE BARRIERE!

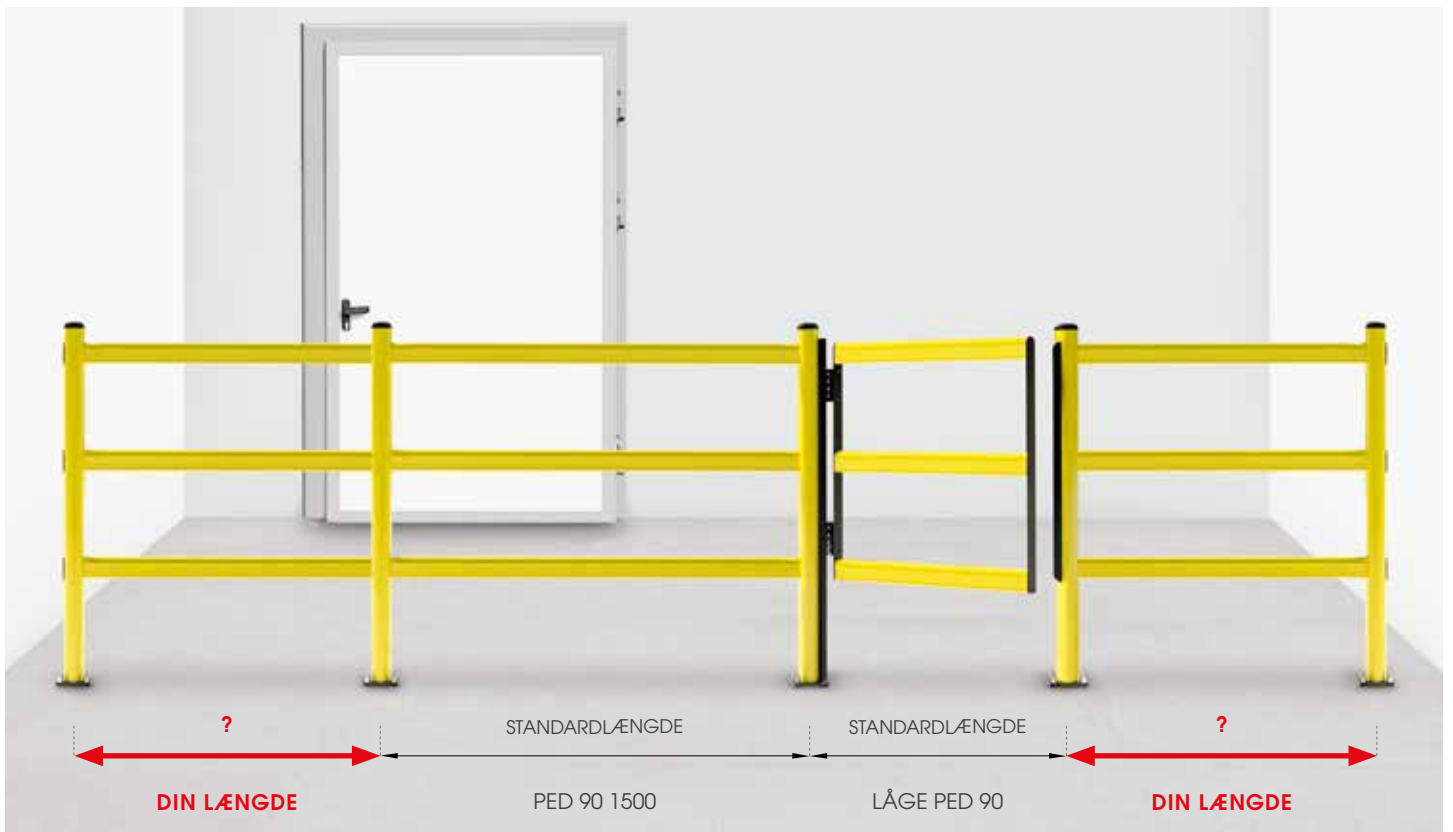

01



HØJ
STØDDÆMPNING

REOLBESKYTTELSE

Komplet program af stigebensbeskyttelse til Reolben

VORES PROFILER PASSER ALLE REOLBEN



NEM
MONTAGE

MED TRESIDET
BESKYTTELSE

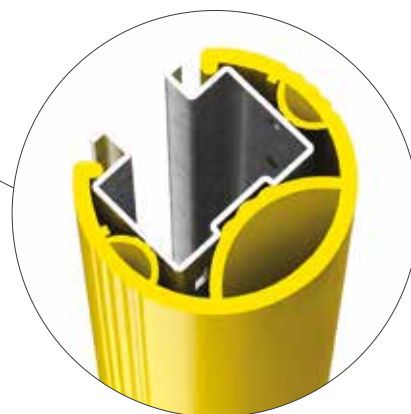

RPS 600

60 80



Pakning 6 stk/ kasse
Pakning 114 stk / stor kasse
Farve M

Tilgængelig i 400 mm

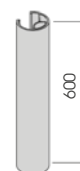

RPM 600

80 100



Pakning 4 stk/ kasse
Pakning 80 stk / stor kasse
Farve M

Tilgængelig i 400 mm

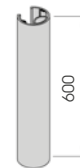

RPL 600

100 120



Pakning 2 stk/ kasse
Pakning 54 stk / stor kasse
Farve M

Tilgængelig i 400 mm



RPXL 600

100 120



Pakning kan specificeres
Farve M

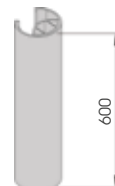

RP KLIK

Pakning 1 stk/ kasse

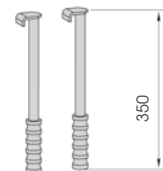

RPF 600

Med tilbehør

60 130



Pakning 2 stk/ kasse
Farve C

Akselafstand
25 - 50 - 75 mm

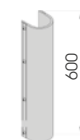

Endegalvsbeskyttelse

SM



FØRSKELLIGE
STØRRELSER EFTER
OPGAVE

HURTIG
OG ENKEL
MONTAGE



M12
GALVANISERET STÅL



SM 1500x400 MODULÆR

Med tilbehør

Pakning
Farve

På palle

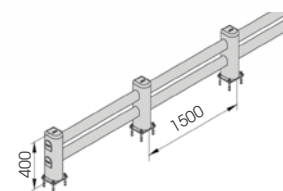

SM 1100x400

Med tilbehør

Længde
Pakning
Farve

1.100

På palle

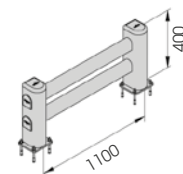

LM



FORSKELLIGE
STØRRELSER EFTER
OPGAVE

HURTIG
OG ENKEL
MONTAGE



M12
GALVANISERET STÅL



LM 2000x500 MODULÆR

Med tilbehør

Pakning
Farve

På palle

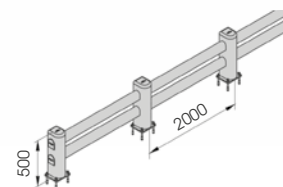

**LM 1100x500
LM 2400x500**

Med tilbehør

Længde
Pakning
Farve

1.100 / 2.400 mm

På palle

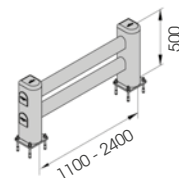

Endegavlsbeskyttelse

FENCE 90



**M12
GALVANISERET STÅL**



FE 90 1100x350

Med tilbehør

Længde **1.100 mm**
Pakning **På palle**
Farve **B M**

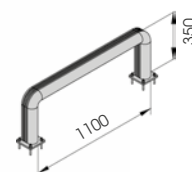

FE 90 2400x350

Med tilbehør

Længde **2.400 mm**
Pakning **På palle**
Farve **B M**

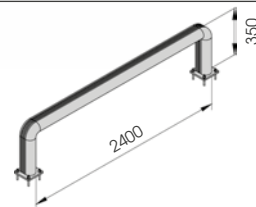

FENCE 150



FORSKELLIGE
STØRRELSER EFTER
OPGAVE

HURTIG
OG ENKEL
MONTAGE



**M12
GALVANISERET STÅL**



FE 150 1100x550

Med tilbehør

Længde **1.100 mm**
Pakning **På palle**
Farve B M



FE 150 2400x550

Med tilbehør

Længde **2.400 mm**
Pakning **På palle**
Farve B M



FENCE 150 REINFORCED



FORSKELLIGE
STØRRELSER EFTER
OPGAVE

HURTIG
OG ENKEL
MONTAGE



M12
GALVANISERET STÅL



FE 150 REF 1100x550
Med tilbehør

Længde **1.100 mm**
Pakning **På palle**
Farve **B M**

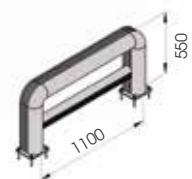

FE 150 2400x550
Med tilbehør

Længde **2.400 mm**
Pakning **På palle**
Farve **B M**

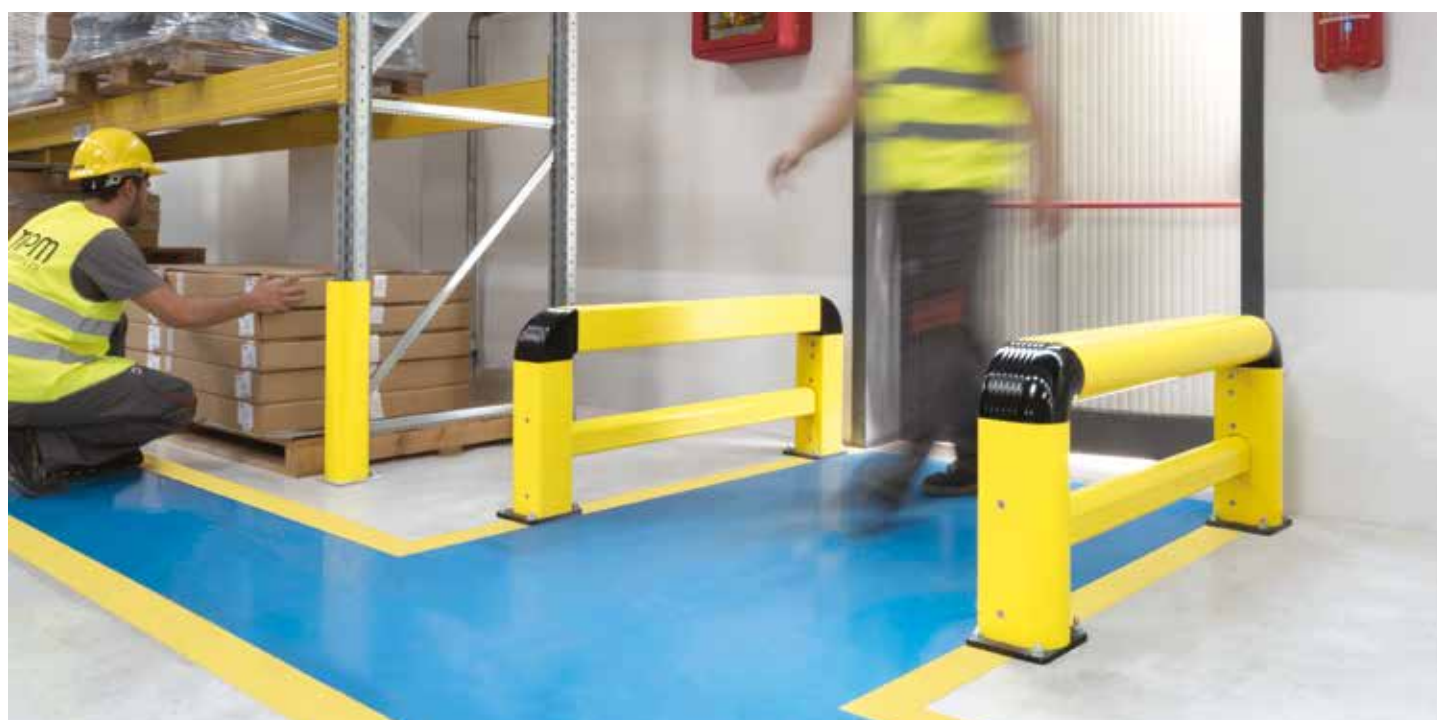

FENCE LINK



FORSKELLIGE
STØRRELSER EFTER
OPGAVE

HURTIG
OG ENKEL
MONTAGE



M12
GALVANISERET STÅL



FE LINK
Med tilbehør

Længde 1.100 mm
Pakning På palle
Farve B M

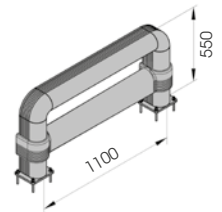

02

PULLERT

Som tilbehør til truckværn se venligst side 20



Designet til at beskytte Porte,
maskiner og bygninger mod påkørsler
eller til markering af områder
for fodgængere, med tilbehør



Pullert

ROD



RE
Enkel at flytte



GALVANISERET STÅL

Bolte også tilgængelige i rustfri



ROD PE 70 266 RE

Med tilbehør

Bor Ø 38



Pakning 6 stk / kasse

Farve C

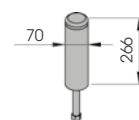

ROD PE 120 433 RE
560 RE

Med tilbehør

Bor Ø 56



Pakning 1 stk / kasse

Farve M

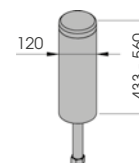

GRD

HURTIG
OG ENKEL
MONTAGE



M12
GALVANISERET STÅL



GRD 90 250
Med tilbehør



Pakning **På palle**
Farve **B M**

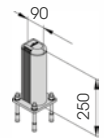

**GRD 150 500
800
1150**
Med tilbehør



Pakning **På palle**
Farve **B M**

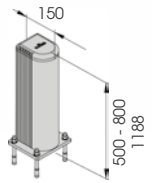

03

PÅKØRSELSVÆRN

Et nyt barriersystem udviklet til at beskytte vægge mod påkørsler. Udviklet i et innovativt design der kombinerer hastighed og enkelthed til både montage og rengøring. Tilgængelig i forskellige længder



TRUCKLINE



FORSKELLIGE
STØRRELSER EFTER
OPGAVE

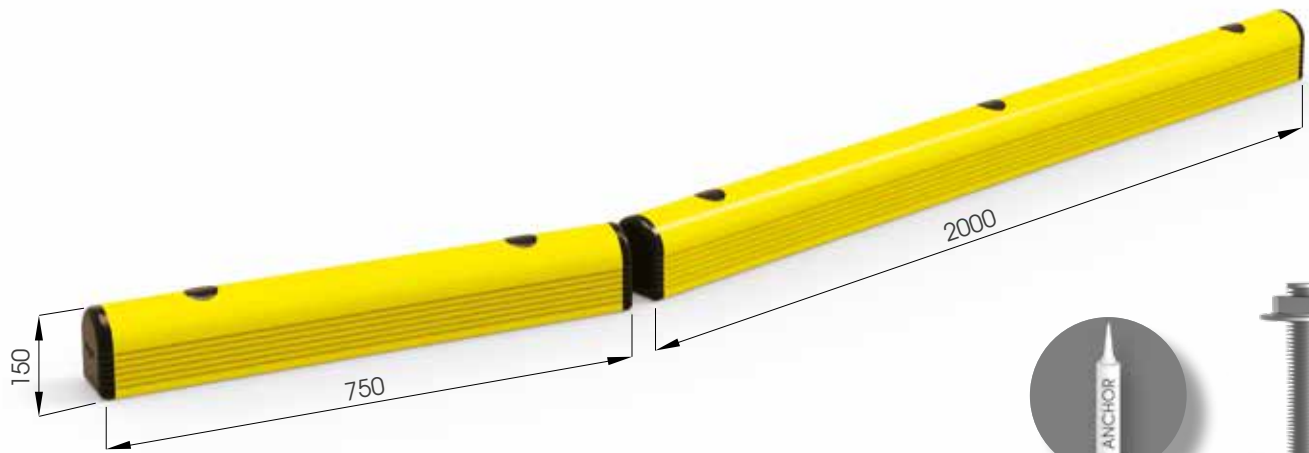

M20
RUSTFRI STÅL



TL

Med tilbehør

Pakning
Farve
efter opgave
M

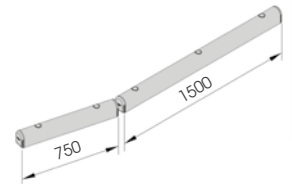

GUARD RAIL 90



**HURTIG
OG ENKEL
MONTAGE**



**M16
GALVANISERET STÅL**

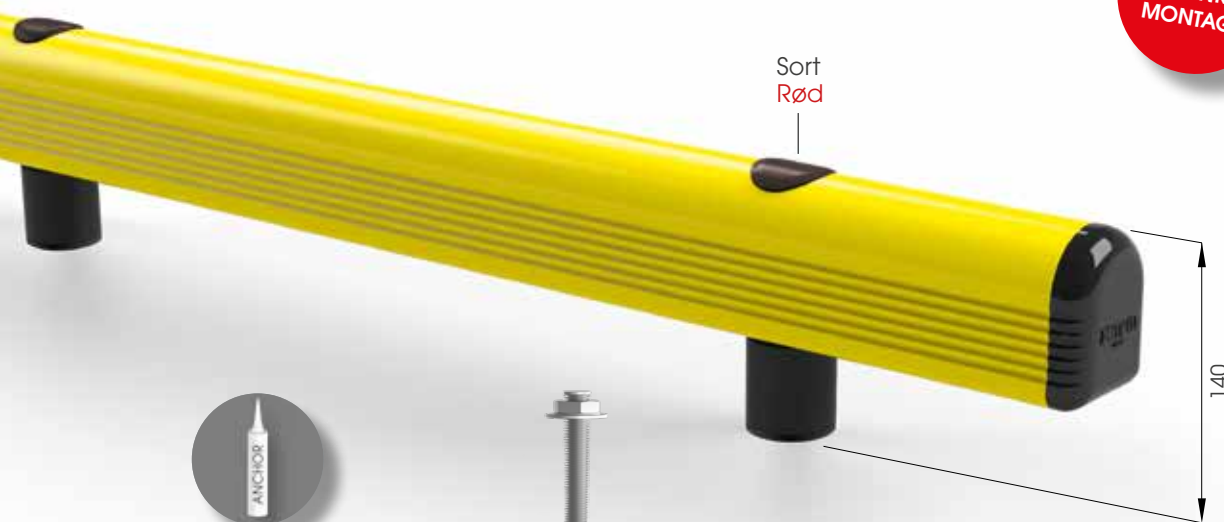

ALTERNATIV BEFÆSTIGELSE
HØJ STYRKE MED LIMANKRE



**M16
RUSTFRI STÅL**



**GR 90 500
750
1000
1500**

Med tilbehør

Længde **500 mm**
Pakning **4 stk / kasse**

Længde **750 / 1000 / 1500 mm**
Pakning **2 stk / kasse**

Farve **B M**

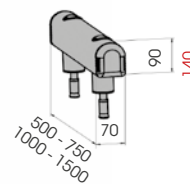

**GR 90 2000
3000
4000**

Med tilbehør

Længde **2.000 / 3.000 / 4.000 mm**
Pakning **2 stk / kasse**
Farve **B M**

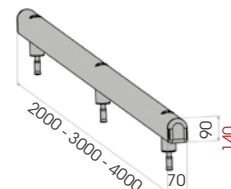

GUARD RAIL 150



M20
RUSTFRI STÅL

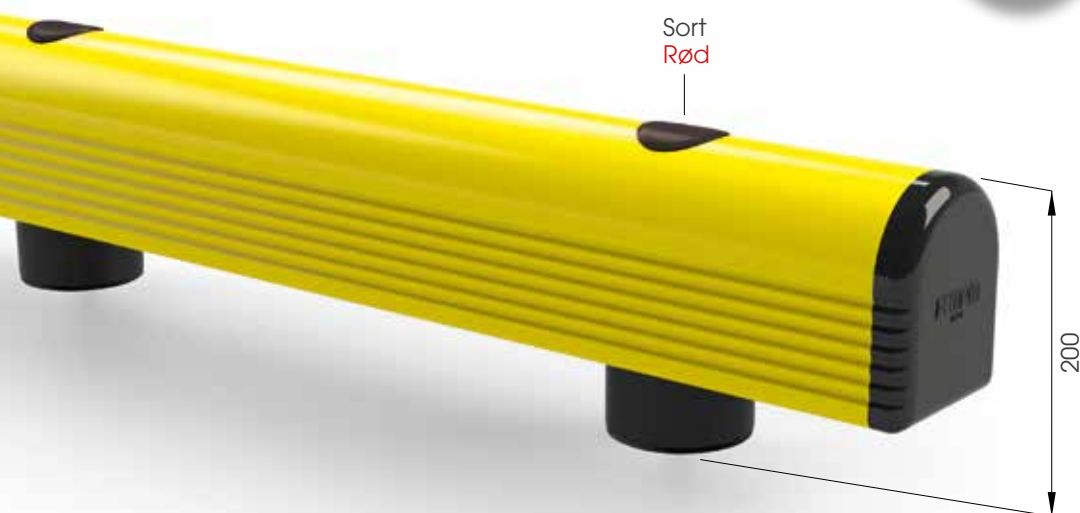

GR 150 500
750
1000
1500

Med tilbehør

Længde 500 / 750 /
1000 / 1500 mm
Pakning På palle
Farve B M

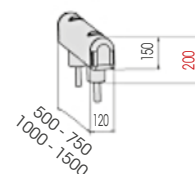

GR 150 2000
3000
4000

Med tilbehør

Længde 2.000 / 3.000 / 4.000 mm
Pakning På palle
Farve B M

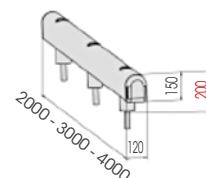

GRIN 90

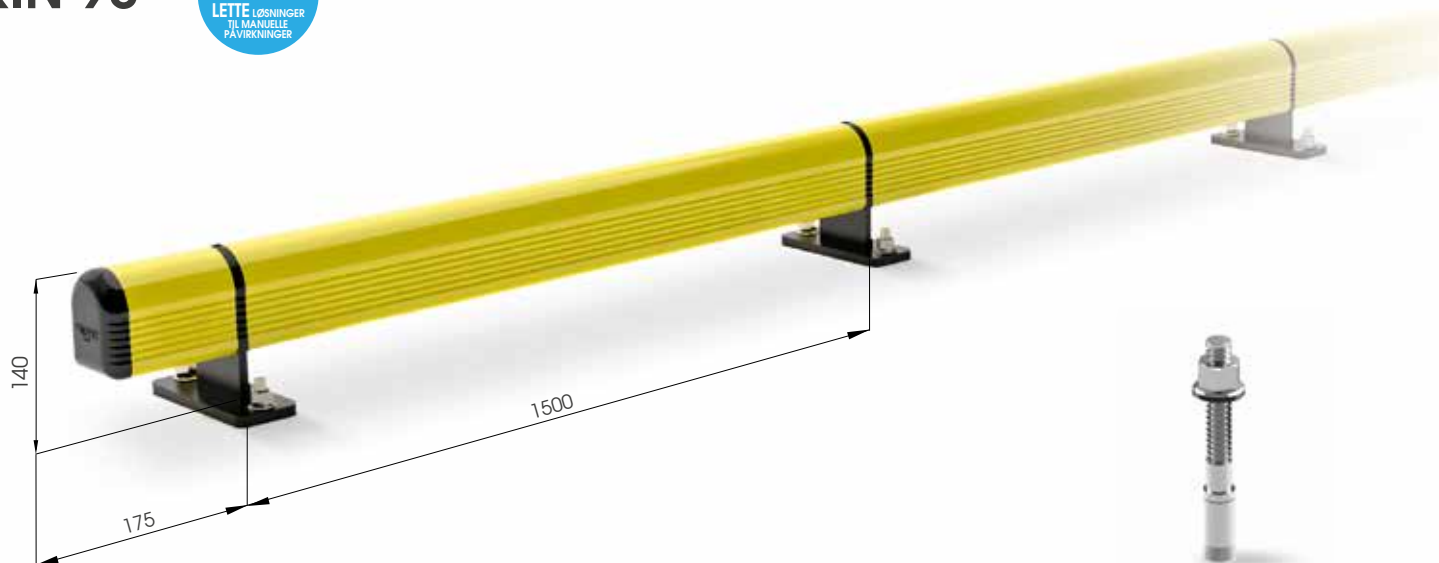

**M12
GALVANISERET STÅL**



GRIN 90 1500

Længde **1500 mm**
Pakning **efter opgave**
Farve **M**

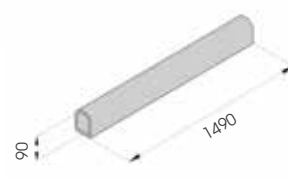

GRINCO 90
Med tilbehør

Pakning **efter opgave**
Farve **M**



GRINT 90
Med tilbehør

Pakning **efter opgave**
Farve **M**

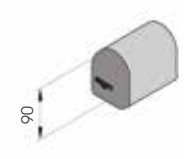

GRIN 150



**M12
GALVANISERET STÅL**



GRIN 150 2000

Længde **2000 mm**
Pakning **efter opgave**
Farve **M**

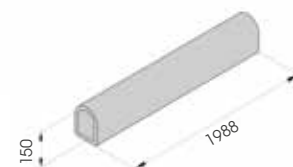

GRINCO 150
Med tilbehør

Pakning **efter opgave**
Farve **M**



GRINT 150
Med tilbehør

Pakning **efter opgave**
Farve **M**

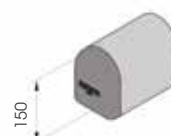

04

FODGÆNGERVÆRN

Et nyt beskyttelsessystem, specielt designet til at beskytte og guide fodgænger i områder med truckkørsel. Udviklet i et innovativt design der sikrer hurtig montage og efterfølgende rengøring.



HAND RAIL 90



HURTIG OG ENKEL MONTAGE

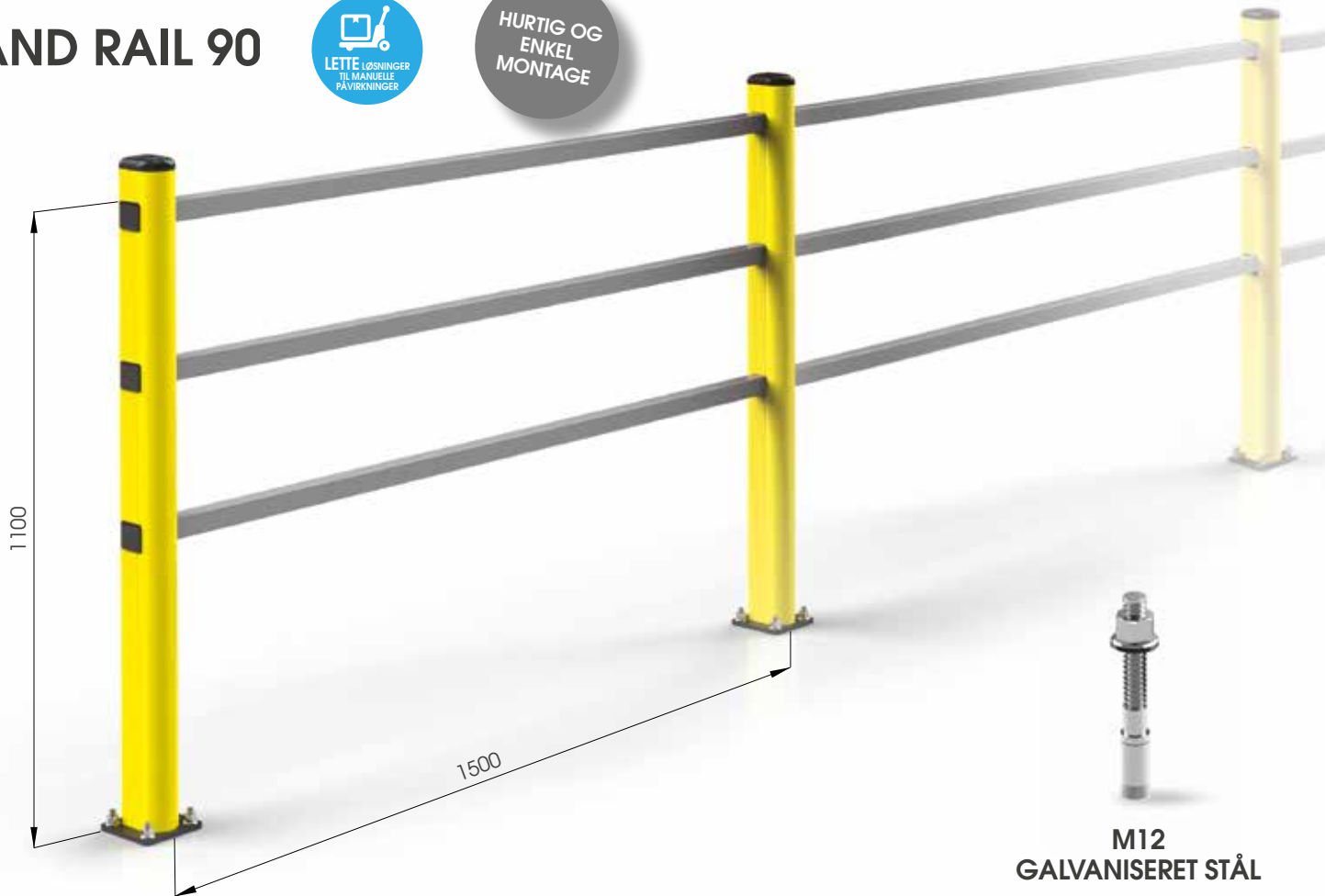

M12 GALVANISERET STÅL



HR 90 1500x1150 MODULÆR
Med tilbehør

Pakning **på palle**
Farve **M**

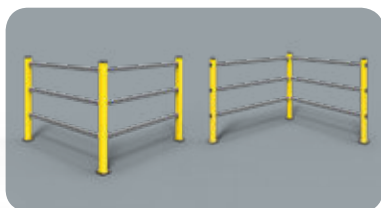
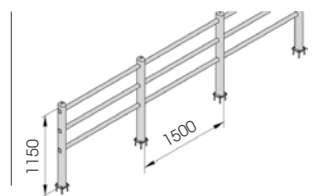

HR 90 1500x1150 HJØRNE
Med tilbehør

Pakning **på palle**
Farve **M**

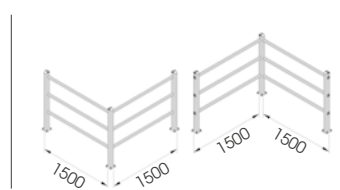

PED 90



LETTE LØSNINGER
TIL MANUELLE
PÅVIRKNINGER

HURTIG OG
ENKEL
MONTAGE



M12
GALVANISERET STÅL



PED 90 1500x1150 MODULÆR

Med tilbehør

Pakning På palle
Farve B M

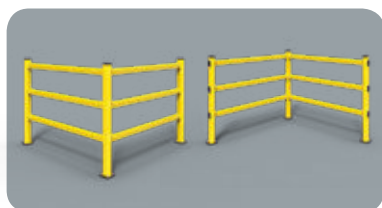
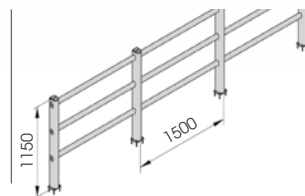

PED 90 1500x1150 HJØRNE

Med tilbehør

Pakning På palle
Farve B M

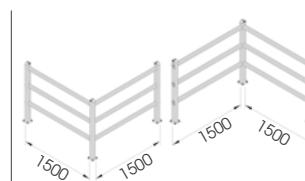

PED 150



HURTIG OG ENKEL MONTAGE



M12 GALVANISERET STÅL



PED 150 2000x1150 MODULÆR
Med tilbehør

Pakning På palle
Farve B M

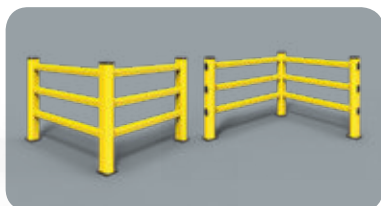
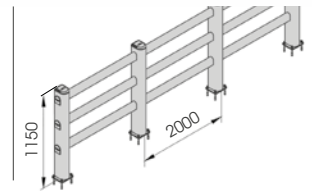

PED 150 2000x1150 HJØRNE
Med tilbehør

Pakning På palle
Farve B M

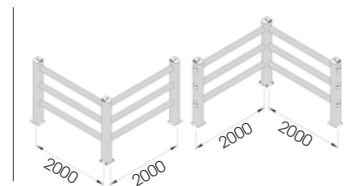

PED 90 FORSTÆRKET



HURTIG OG ENKEL MONTAGE



M12 GALVANISERET STÅL



PED 90 REF MODULÆR
Med tilbehør

Pakning efter opgave
Farve B M

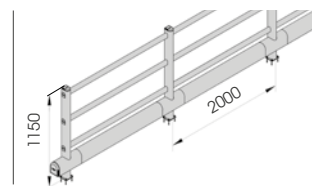

REOLBESKYTTELSE

ALTID FLEKSIBEL

+ KOMPAKT + RECIRKULERBAR + HOLDBAR



Global SafeZone ApS

05

LÅGER

Låger i forskellige dimensioner ideelle til at integrere med vores fodgængerværn. Designet til hurtig installation og rengøring.



FULD RAMME



HURTIG OG ENKEL MONTAGE

FORSKELLIGE STØRRELSER EFTER OPGAVE

VALGMULIGHED: TILBEHØR TIL VÆG BEFÆSTIGELSE

NYT STØRRE BUNDPLADER!

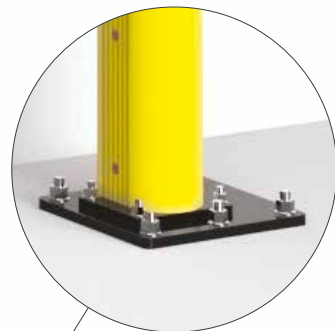

M16 RUSTFRI STÅL



Låger

LÅGE PED 90

FORSKELLIGE
STØRRELSER EFTER
OPGAVE

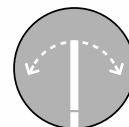

NY SVINGLÅGE
ÅBNING



MIN 600 MAX 1000



**DP 90
EN VEJ**

Med tilbehør

Pakning **efter opgave**
Farve **M**

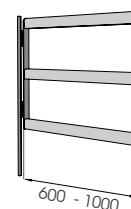

**DP 90
SVING**

Med tilbehør

Pakning **efter opgave**
Farve **M**

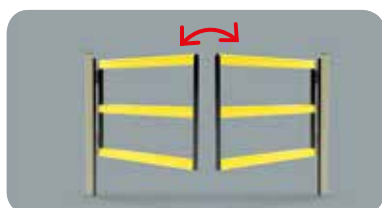
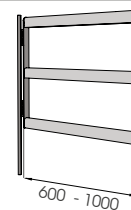

**DP 90
DOBBELT
SVING**

Med tilbehør

Pakning **efter opgave**
Farve **M**

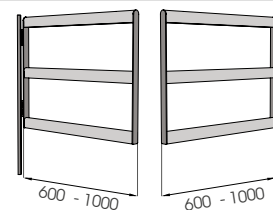

LÅGE PED 150

FORSKELLIGE
STØRRELSER EFTER
OPGAVE

NY SVINGLÅGE
ÅBNING



**DP 150
EN VEJ**

Med tilbehør

Pakning **efter opgave**
Farve **M**

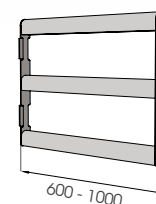

**DP 150
SVING**

Med tilbehør

Pakning **efter opgave**
Farve **M**

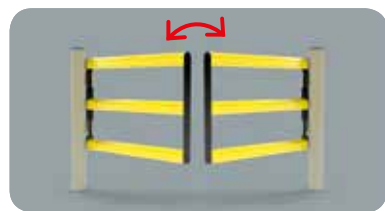
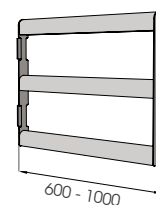

**DP 150
DOBBELT
SVING**

Med tilbehør

Pakning **efter opgave**
Farve **M**

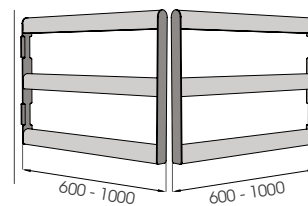

LIFT GATE 90

FORSKILLIGE
STØRRELSER EFTER
OPGAVE

NYT

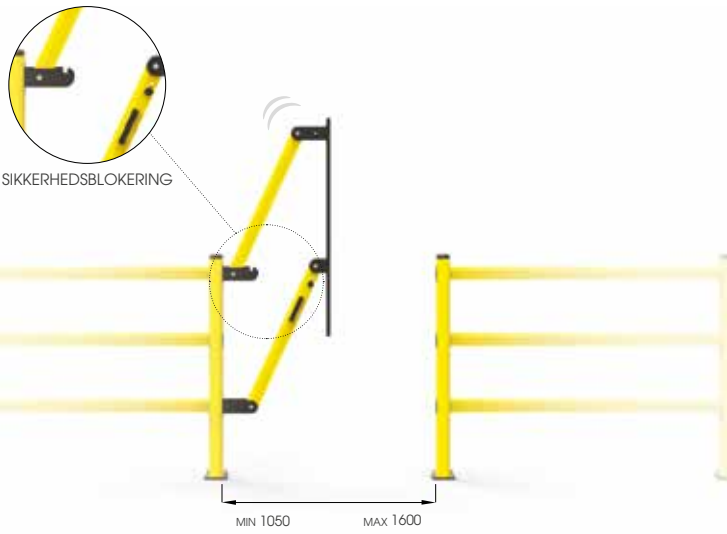

LIFT GATE 90 DOUBLE



DOBBELT LÅGE

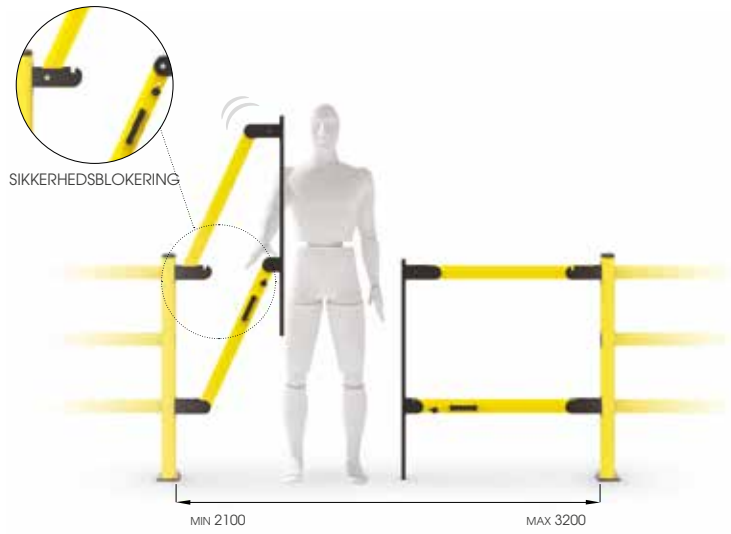

LIFT GATE 90

Med tilbehør

Pakning **efter opgave**
Farve **M**

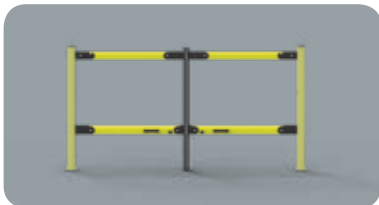

LIFT GATE 90 DOUBLE

Med tilbehør

Pakning **efter opgave**
Farve **M**





DOBBELT LÅGE

LIFT GATE 150

FORSKELLIGE
STØRRELSER EFTER
OPGAVE

NYT



SIKKERHEDSBLOKERING



LIFT GATE 150 DOUBLE



SIKKERHEDSBLOKERING

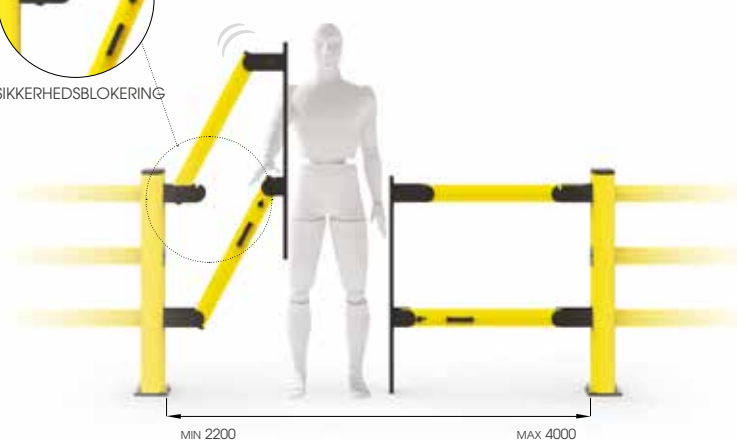

LIFT GATE 150

Med tilbehør

Pakning **efter opgave**
Farve **M**

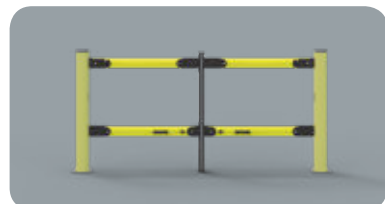
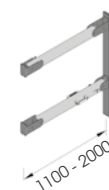

LIFT GATE 150 DOUBLE

Med tilbehør

Pakning **efter opgave**
Farve **M**



06

Første system i verden der kan tilpasses i højden, takket være nyt koblingssystem, der også giver hidtil uset styrke.

LINK

**NYT
PRODUKT**



**HØJDE
ANPASSET**



**KUNDENS
ØNSKER**



LINK 150/3



FORSKELLIGE
STØRRELSER EFTER
OPGAVE



M12
GALVANISERET STÅL

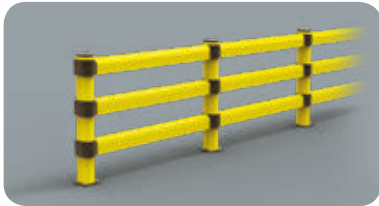

LINK 150/3

Pakning **efter opgave**
Farve **M**

Med tilbehør

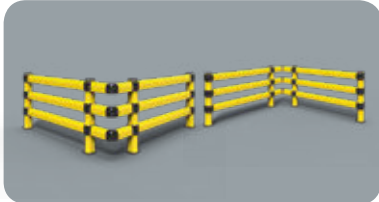
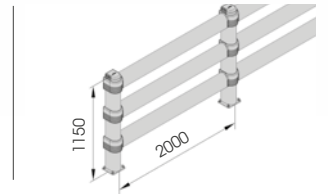

LINK 150/3
HJØRNE

Pakning **efter opgave**
Farve **M**

Med tilbehør

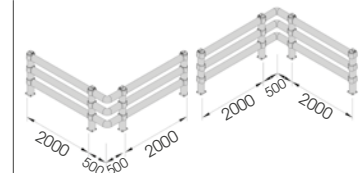

Link

LINK 150/2



FORSKELLIGE
STØRRELSER EFTER
OPGAVE

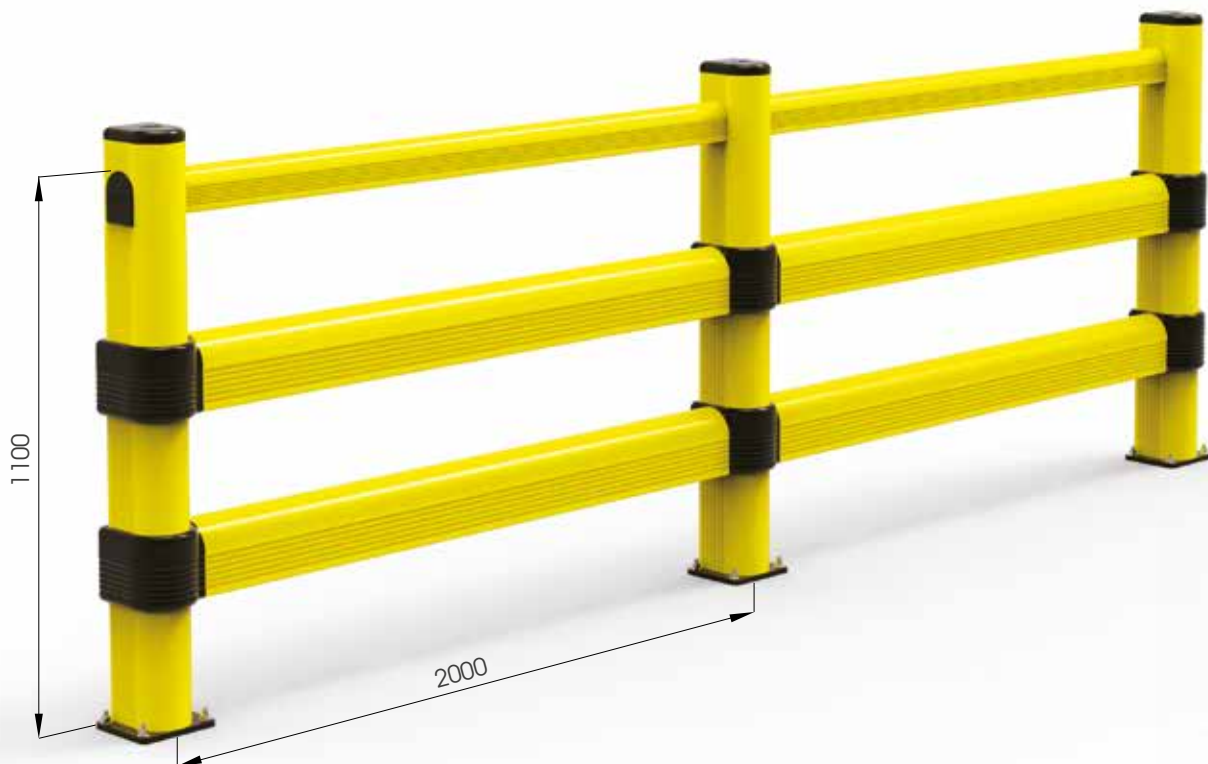

M12
GALVANISERET STÅL



LINK 150/2

Med tilbehør

Pakning efter opgave
Farve M

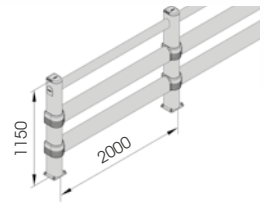

LINK 150/1



FORSKILLEGE STØRRELSER EFTER OPGAVE

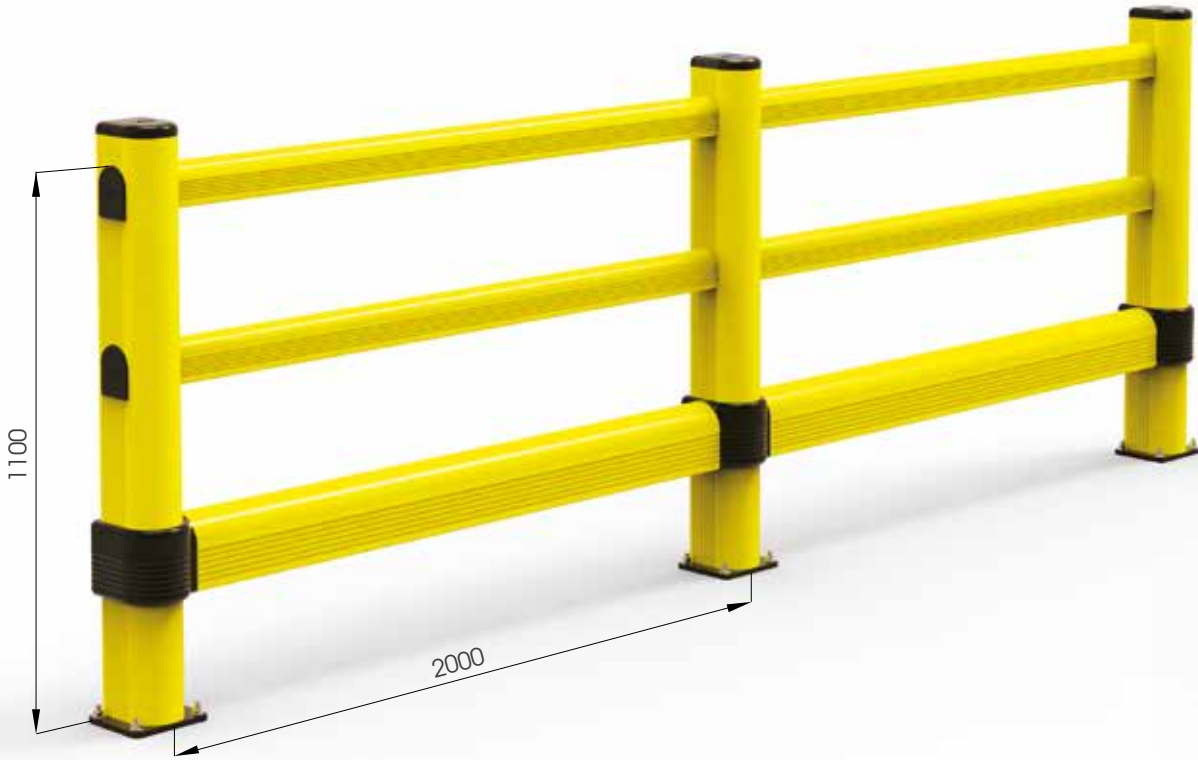

M12 GALVANISERET STÅL



LINK 150/1

Pakning efter opgave
Farve M

Med tilbehør

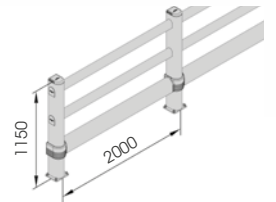

Link

LINK LM



FORSKELLIGE
STØRRELSER EFTER
OPGAVE



M12
GALVANISERET STÅL

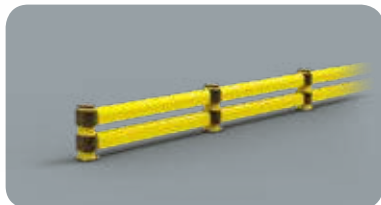

LINK LM 500
800

Med tilbehør

Pakning **efter opgave**
Farve **M**

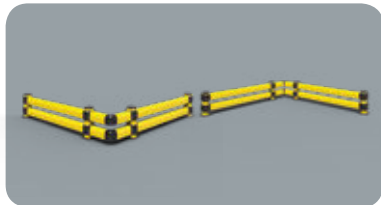
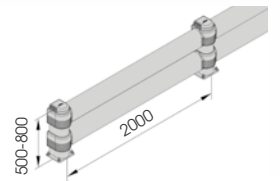

LINK LM
HJØRNE

Med tilbehør

Pakning **efter opgave**
Farve **M**

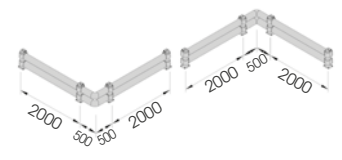

LINK SINGLE



FORSKELLIGE
STØRRELSER EFTER
OPGAVE

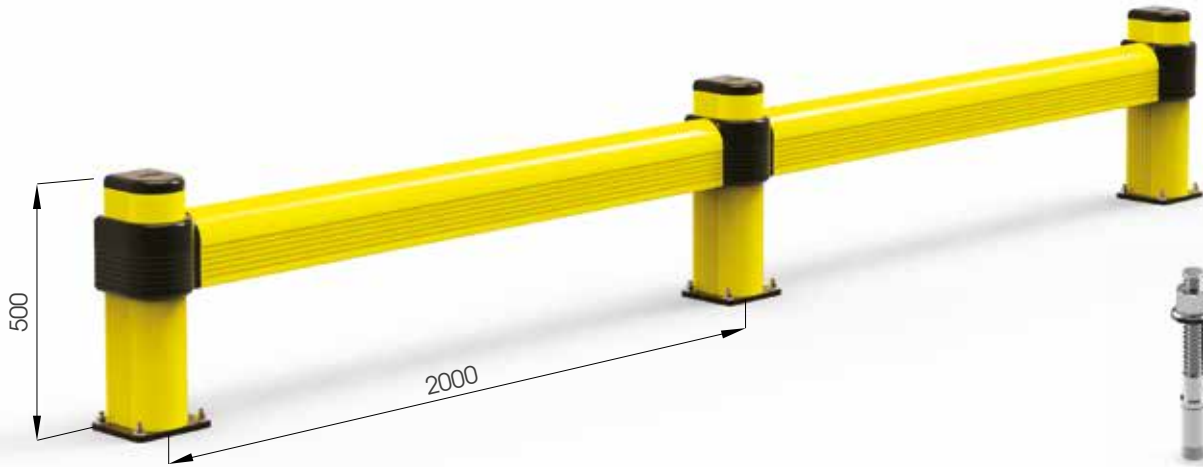

**M12
GALVANISERET STÅL**

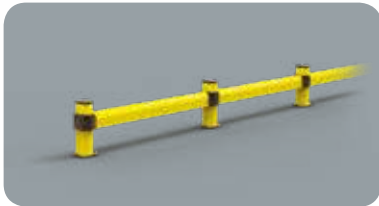

LINK SINGLE

Med tilbehør

Pakning **efter opgave**
Farve **M**

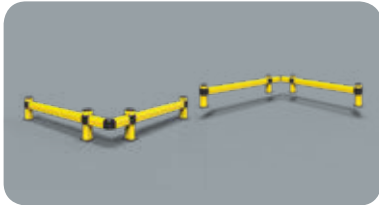
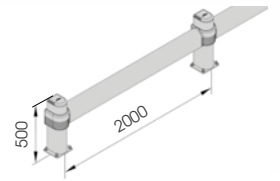

**LINK SINGLE
HJØRNE**

Med tilbehør

Pakning **efter opgave**
Farve **M**

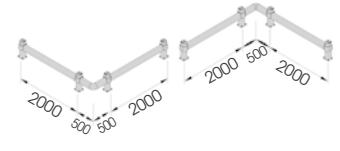

NYE VALGMULIGHEDER
TIL VORES PÅKØRSELSVÆRN
OG REOLBESKYTTELSE



NYE VALGMULIGHEDER

TILGÆNGELIG TIL:
SM / LM / FENCE
HR 90 / PED 90 / PED 150



3



4

07

SØJLEBESKYTTELSE

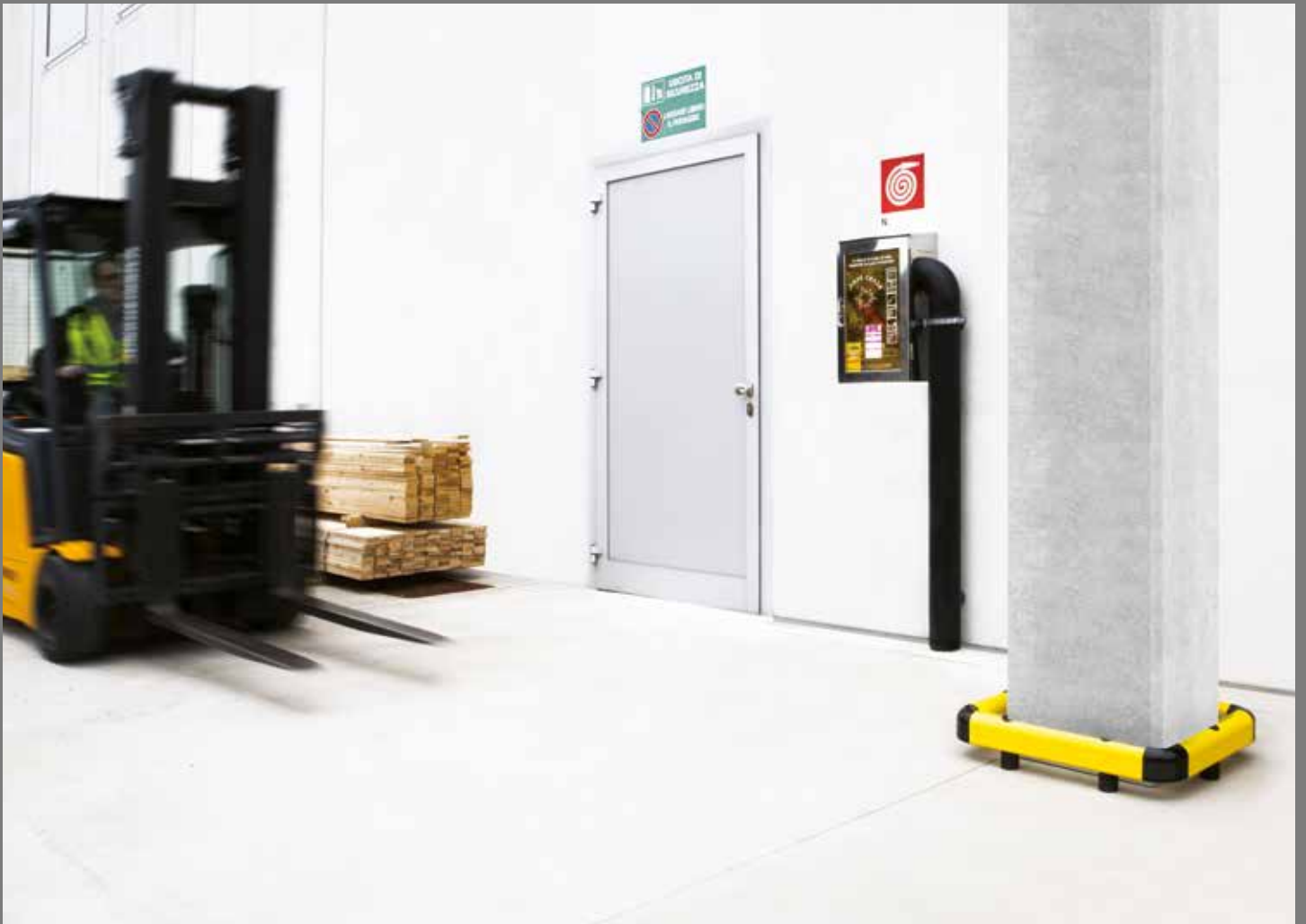

Et nyt system beregnet til søjlebeskyttelse mod påkørsler af forskellig styrke. Designet til hurtig og enkel montage. Tilgængelig i forskellige højder og med forskellige befæstigelser.



- FLYTBAR
- INGEN RIDSER
- HØJ STYRKE OG PLADSBESPARENDE
- IKKE FASTGJORT TIL SØJLEN

Søjlebeskyttelse

SØJLEBESKYTTELSE CP90



FORSKELLIGE
STØRRELSER EFTER
OPGAVE

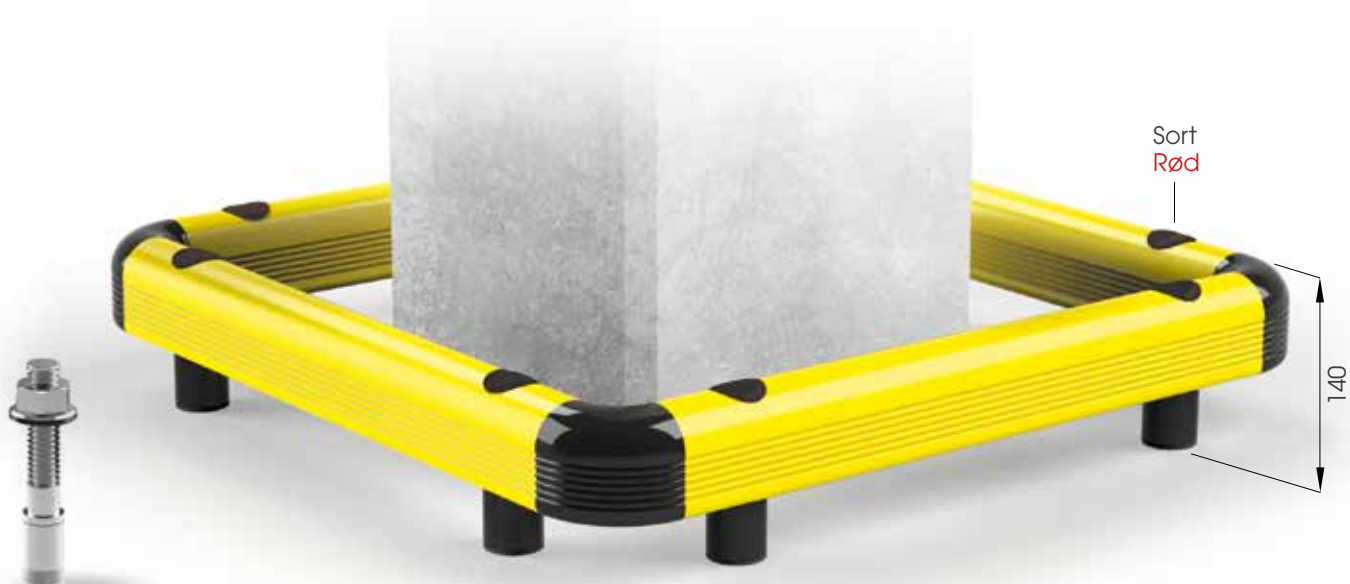

M16
RUSTFRI STÅL



COPRO 90 500x500
600x600
700x700

Med tilbehør

Pakning på palle
Farve 

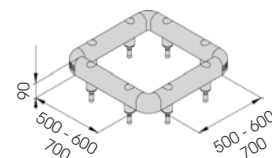

SØJLEBESKYTTELSE CP150



FORSKELLIGE
STØRRELSER EFTER
OPGAVE



M20
RUSTFRI STÅL



COPRO 150 500x500
600x600
700x700

Med tilbehør

Pakning på palle
Farve **M**

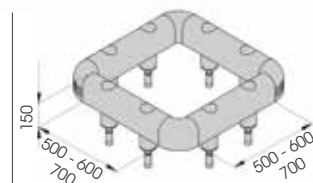

HUG TOWER



FORSKELLIGE
STØRRELSER EFTER
OPGAVE

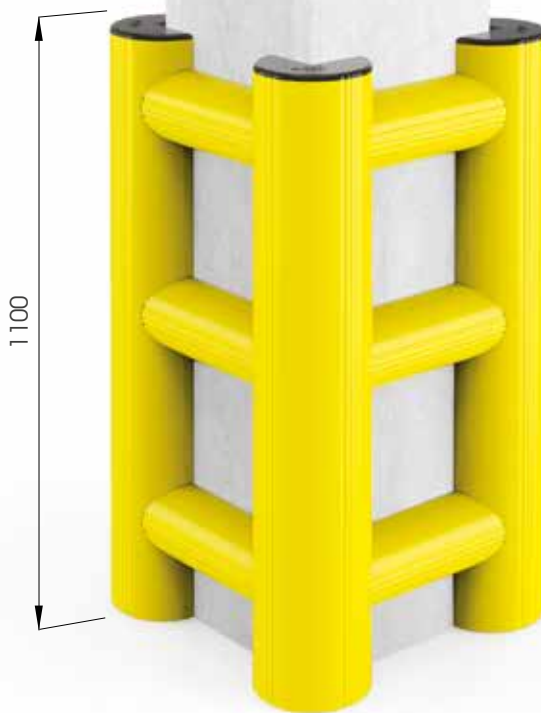

COMPACT



**INGEN HULLER
I GULV ELLER SØJLE**



**TOWER 500x500
600x600
700x700**

Med tilbehør

Pakning efter opgave
Farve **M**

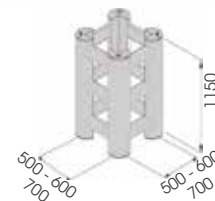

TOWER PROTECTION



FORSKELLIGE
STØRRELSER EFTER
OPGAVE



M12
Galvaniseret stål



TOWER 500x500
600x600
700x700

Med tilbehør

Pakning **efter opgave**
Farve **M**

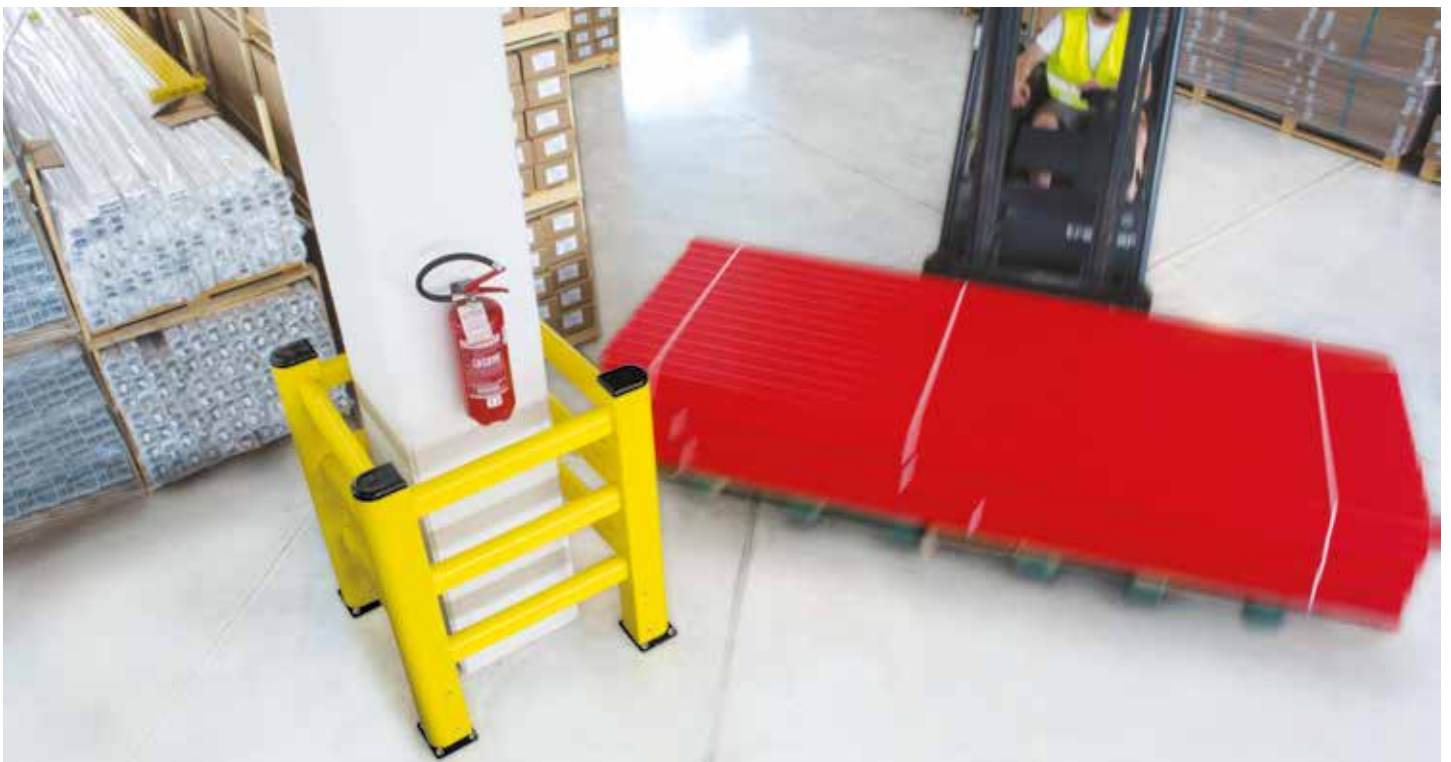
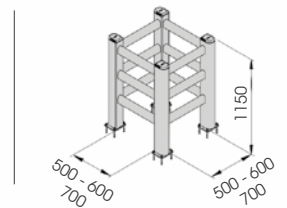

08

HJØRNEBESKYTTELSE

Designet til at beskytte kritiske hjørner





CP 100

Længde **4.000 mm**
 Pakning **10 stk / kasse**
 Farve **B M E F**

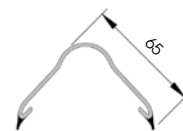

CPF 100

Længde **4.000 mm**
 Pakning **10 stk / kasse**



CPT 100

Pakning **40 stk / kasse**
 Farve **B E F**

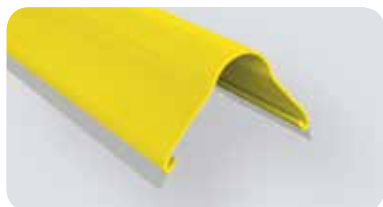
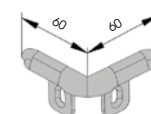

CP 200

Længde **4.000 mm**
 Pakning **2 stk / kasse**
 Farve **B M E**
 Længde **2.000 mm**
 Pakning **2 stk / kasse**
 Farve **M**

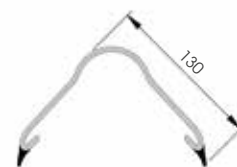

CPF 200

Længde **2.000 / 4.000 mm**
 Pakning **2 stk / kasse**



CPT 200

Pakning **20 stk / kasse**
 Farve **B E**

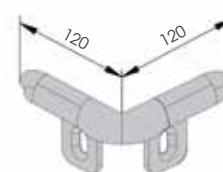

09

BUNDLISTE

Installeres med CH og CU



Et fuldt udbygget barriersystem, ideelt til beskyttelse af vægge og paneler. Nem montage og rengøring. Fuldt udstyret med hjørner og dækpropper.

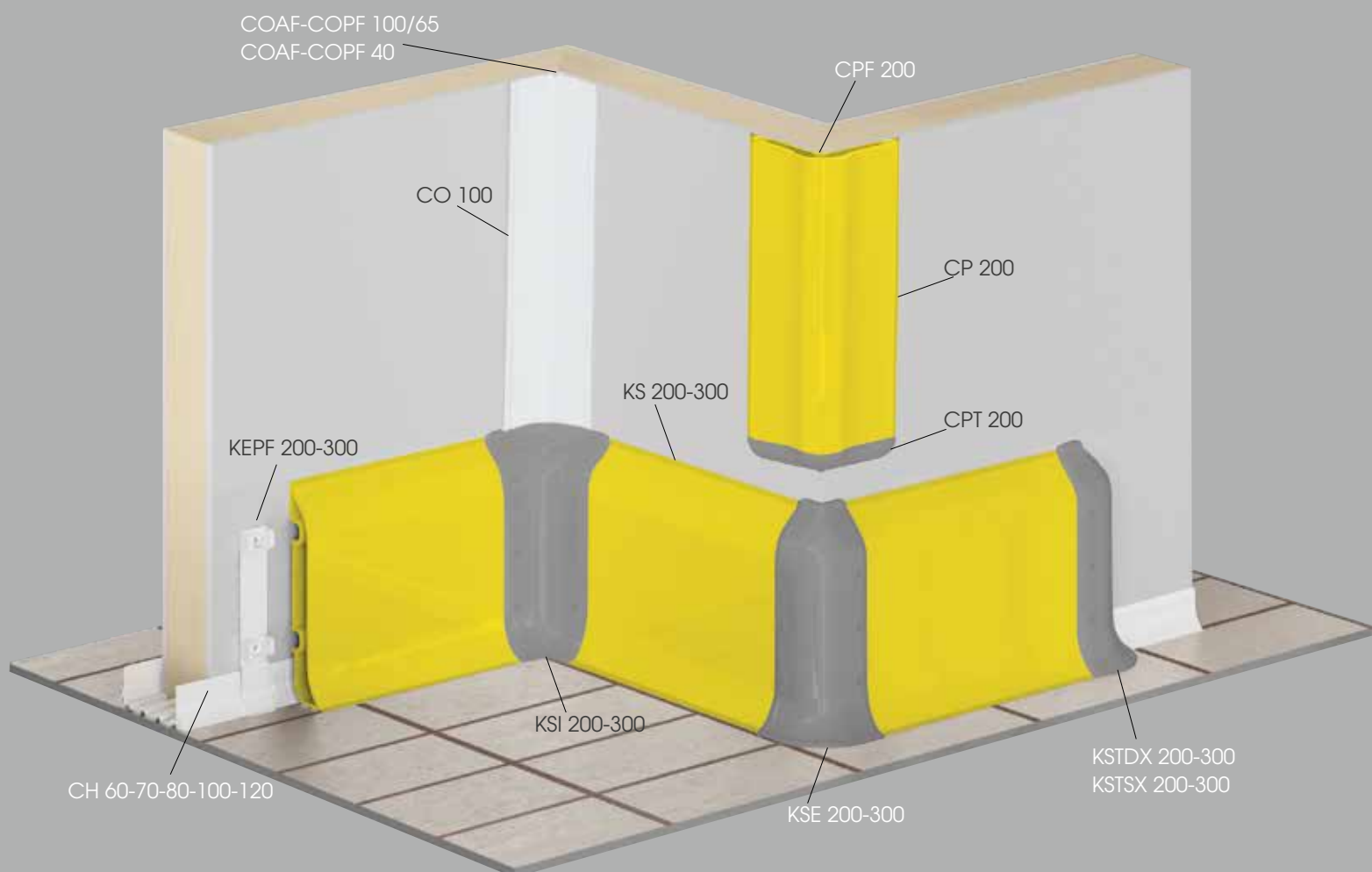

Bundliste



KS 200

Længde **4.000 mm**
 Pakning **3 stk / kasse**
 Farve **B M E**

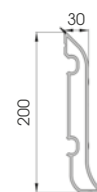

KEPF 200

Installeres med TB14

Pakning **50 stk / kasse**
 Farve **K**

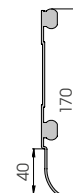

KSJ 200

Installeres med TB14/TF 14

Pakning **20 stk / kasse**
 Farve **B E**

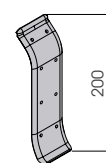

KSI 200

Installeres med TB14/TF 14

Pakning **20 stk / kasse**
 Farve **B E**

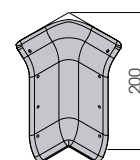

KSE 200

Installeres med TB14/TF 14

Pakning **20 stk / kasse**
 Farve **B E**

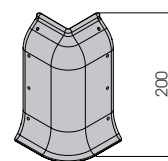

KSTD/SX 200

Installeres med TB14/TF 14

Pakning **20 stk / kasse**
 Farve **B E**

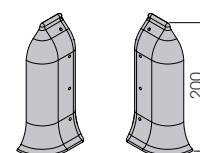

KSJ 200 LT



Pakning **to be defined**
 Farve **K**

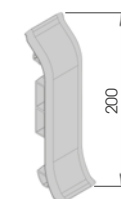

KS 300

Længde **4.000 mm**
 Pakning **1 stk**
 Farve **B M E**

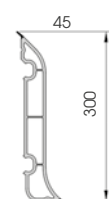

KEPF 300

installeres med TB20

Pakning **40 stk / kasse**

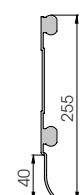



KSJ 300
 Installeres med TB20 / TF20

Pakning 10 stk / kasse
 Farve B E

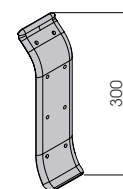

KSI 300
 Installeres med TB20 / TF20

Pakning 10 stk / kasse
 Farve B E

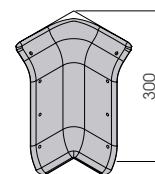

KSE 300
 Installeres med TB20 / TF20

Pakning 10 stk / kasse
 Farve B E

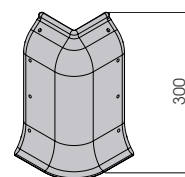

KSTD/SX 300
 Installeres med TB20 / TF20

Pakning 10 stk / kasse
 Farve B E

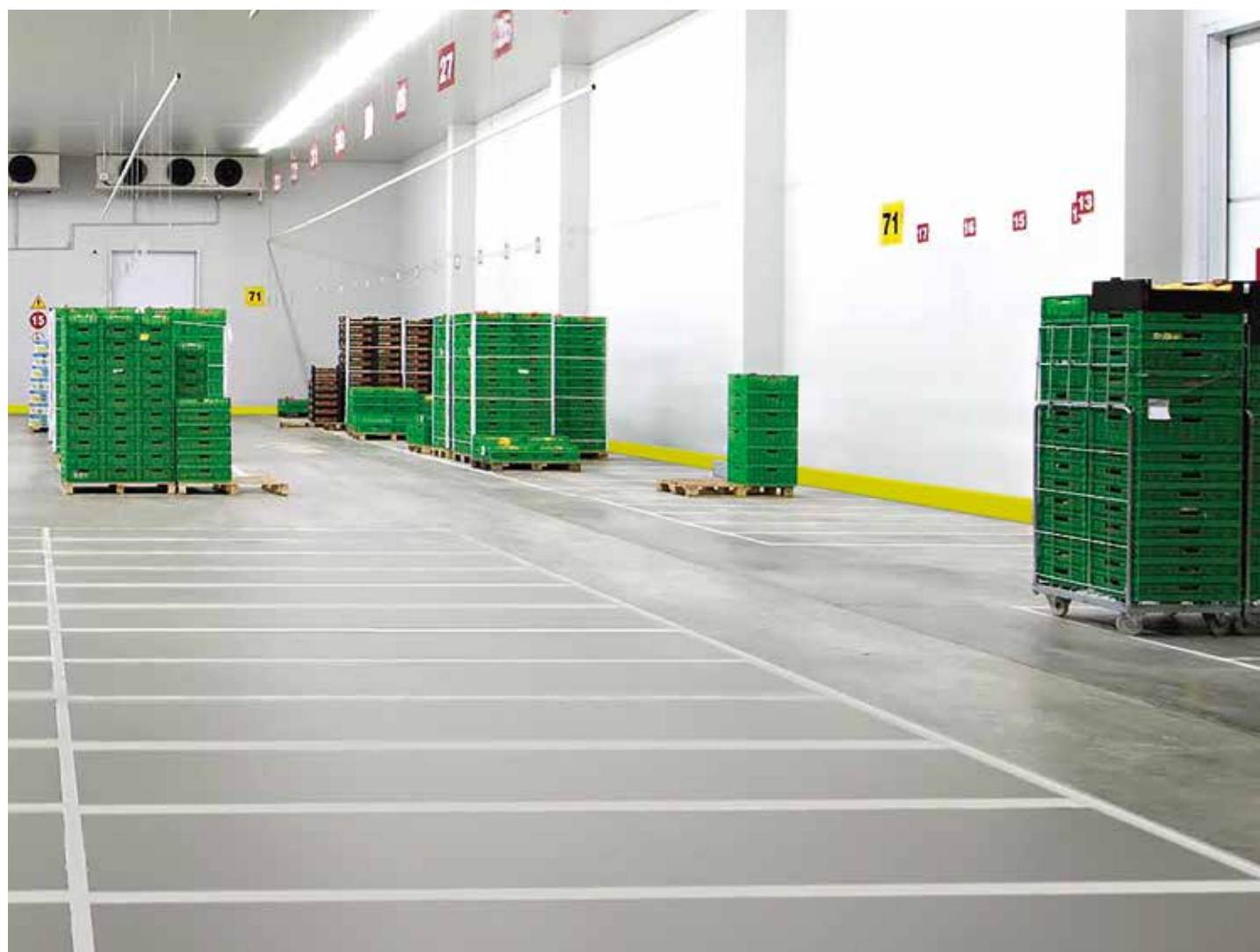
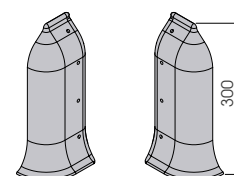

10

VÆGBESKYTTERE

Nye vægbeskyttere der takket være deres størrelse er egnet til beskyttelse i industrielle områder. Med faste låg og gemte skruer.



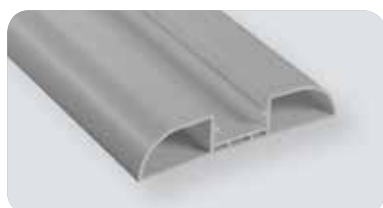
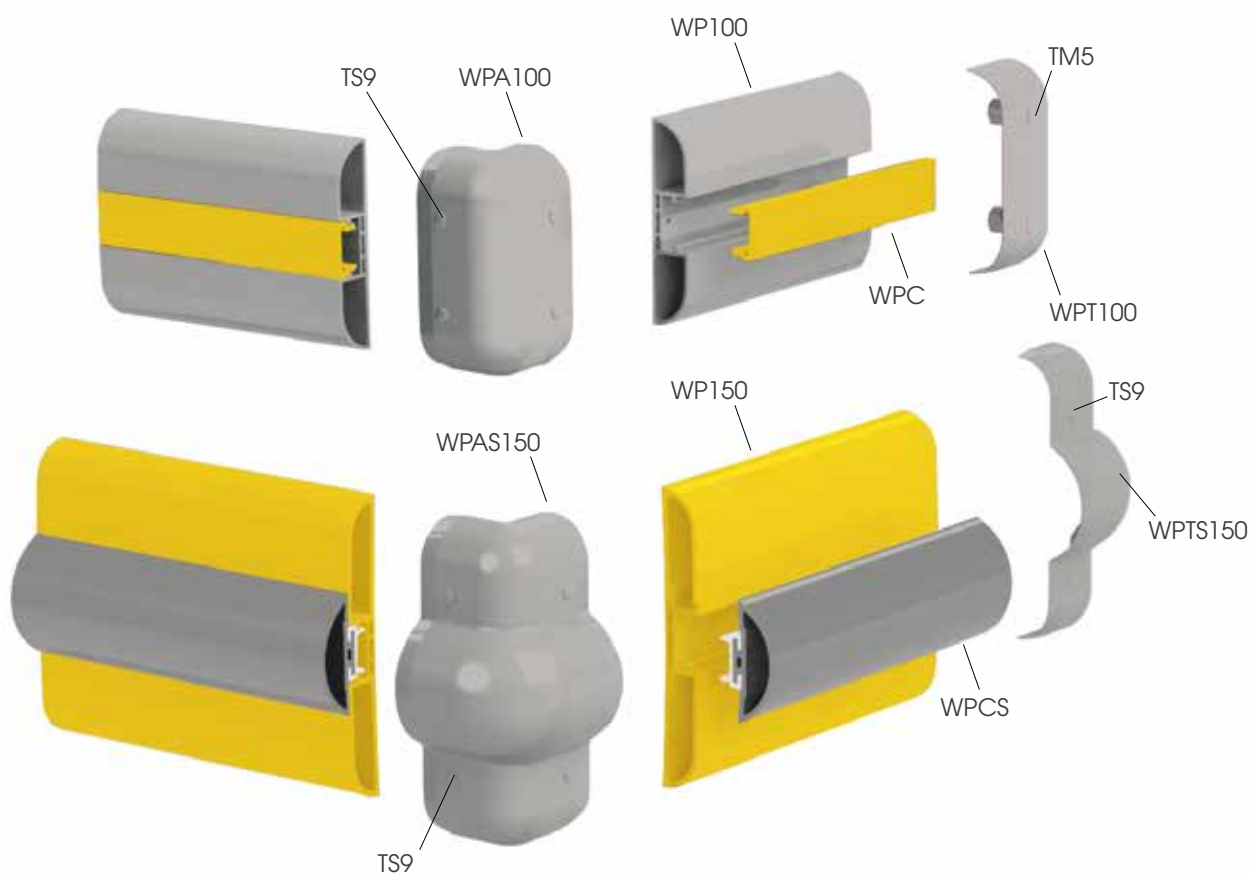

WP 100

Længde **4.000 mm**
 Pakning **8 stk / kasse**
 Farve **B E F**

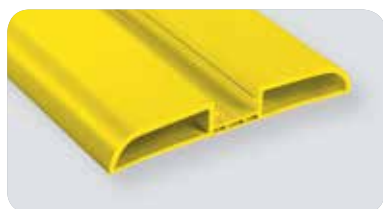
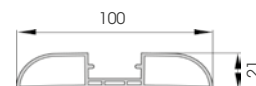

WP 150

Længde **4.000 mm**
 Pakning **4 stk / kasse**
 Farve **B M E**

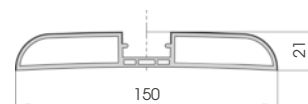

WPC

Installeres med WP 100 / WP 150

Længde **4.000 mm**
 Pakning **16 stk / kasse**
 Farve **A B M D E F G H**

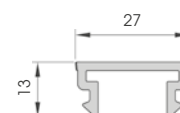

Vægbeskyttere



WPT 100

Installeres med TM5

Pakning **50 stk / kasse**

Farve B E F

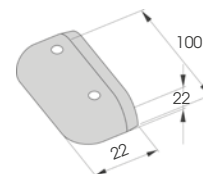

WPA 100

Installeres med TS9

Pakning **20 stk / kasse**

Farve B E

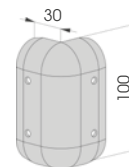

WPT 150

Installeres med TM5

Pakning **50 stk / kasse**

Farve B E

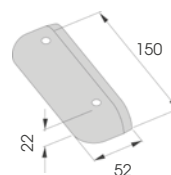

WPA 150

Installeres med TS9

Pakning **20 stk / kasse**

Farve B E

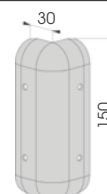

WPCS

Installeres med WP 100 / WP 150

Længde **4.000 mm**

Pakning **8 stk / kasse**

Farve A B M D E
F G H I



WPTS 100

Installeres med TS9

Pakning **20 stk / kasse**

Farve B E

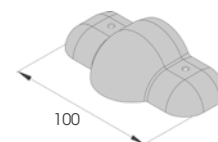

WPAS 100

Installeres med TS9

Pakning **20 stk / kasse**

Farve B E

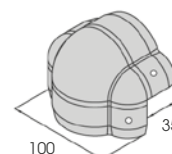

WPTS 150

Installeres med TS9

Pakning **20 stk / kasse**

Farve B E

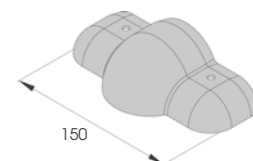

WPAS 150

Installeres med TS9

Pakning **20 stk / kasse**

Farve B E

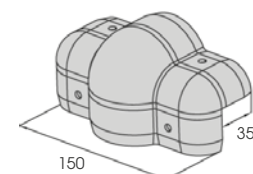

ALTID DE BEDSTE BESKYTTELSVÆRN

VÆLG DET BEDSTE!

Global SafeZone ApS



Vægbeskyttere

Nyt fender- og bundlistesystem udført i elastisk materiale, kan finde anvendelse i kølerum, kølelagre og P-huse.

Takket være materialets elastiske egenskaber giver det en god stødabsorbering og beskyttelse.

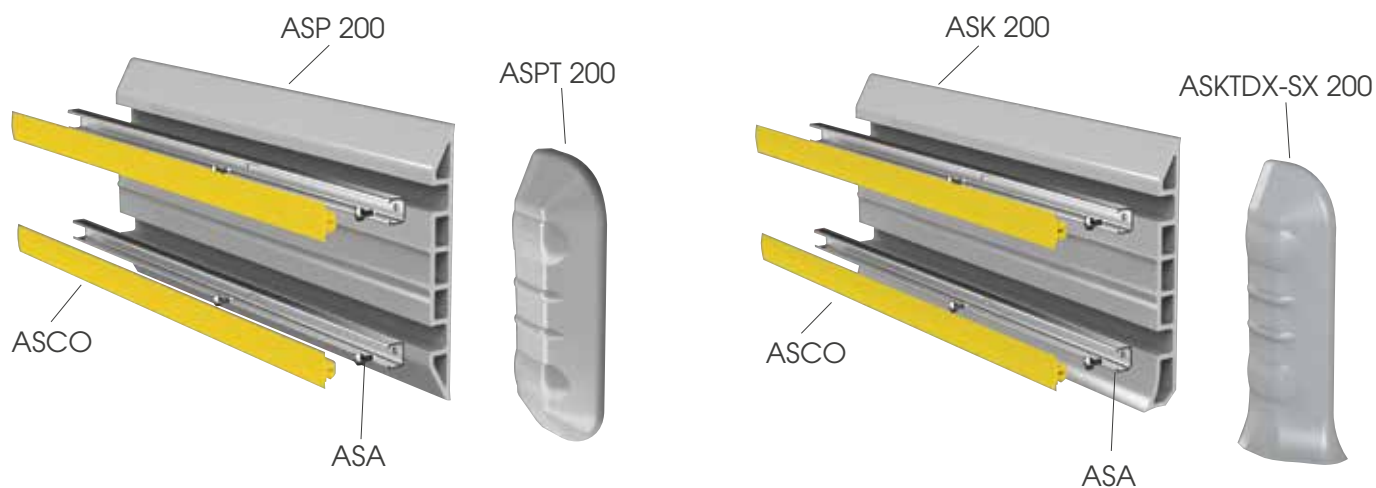



ASK 200



Længde **4.000 mm**
 Pakning **2 stk / kasse**
 Farve **B C**

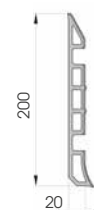

ASK2I200



Pakning **efter opgave**
 Farve **B**



ASK2E 200



Pakning **efter opgave**
 Farve **B**

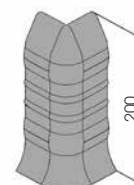

ASKTDX-SX 200



Pakning **efter opgave**
 Farve **B**

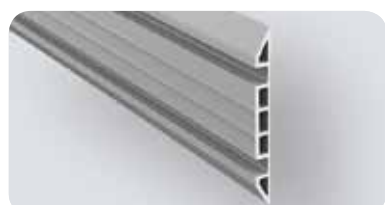

ASP 200



Længde **4.000 mm**
 Pakning **2 stk / kasse**
 Farve **B C**

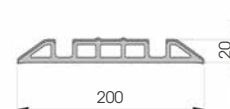

ASPT 200



Pakning **10 stk / kasse**
 Farve **B D**

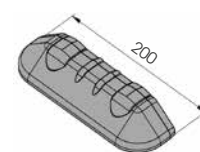

ASA

Material **aluminium**
 Længde **4.000 mm**
 Pakning **8 stk / kasse**

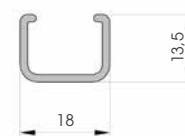

ASCO



Pakning **2 stk / kasse**
 L = **32.000 mm**
 Farve **A B C D G**



11 PVC PANELER



Vinylpaneler til hurtig og omkostningseffektiv renovering af kølerum

FORSKELLEGE
DIMENSIONER EFTER
OPGAVE



PF 300

Foam på indersiden

FOAM PÅ
INDERSIDEN

Længde 3.000/4.000 mm
Pakning 3 stk / kasse
Farve Hvid



PR 300

Længde 3.000/4.000 mm
Pakning 3 stk / kasse
Farve Hvid



PJ

Installeres med PR300 og PF 300

Længde 3.000 mm
Pakning 10 stk / kasse
Farve Hvid

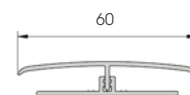

PA

Installeres med PR300 og PF 300

Længde 3.000 mm
Pakning 10 stk / kasse
Farve Hvid

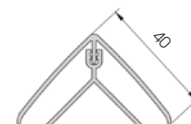

PT

Installeres med PR300 og PF 300

Længde 3.000 mm
Pakning 10 stk / kasse
Farve Hvid

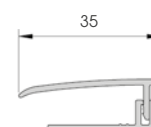



LOFT BARRIER

VERDENS FØRSTE SYSTEM POLYMERSYSTEM
TIL MONTAGE VED NIVEAU FORSKEL



FENCE LINK

DEN STÆRKESTE OG MEST
FLEKSIBLE LØSNING TIL REOLENDER

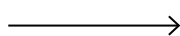

Reolbeskytter produceret efter mål
produceres efter ordre!

KUNDETILPASSET **REOLBESKYTTER**

Tilbehør befæstigelse



TM5
Hulstørrelse Ø 8,5
Neutrale Polyethylene 100 / 500 stk / pose



TS9
Hulstørrelse Ø5
Hvid eller grå Nylon 1000 stk / pose



TB14
Hulstørrelse Ø4
Stål / alu, Hvid 500 / kasse



TB20
Hulstørrelse Ø5
Stål / alu, 500 / kasse



TF14
Hulstørrelse Ø5
Aluminium 500 stk / pose



TF20
Hulstørrelse Ø6,5
Aluminium 500 stk / pose



M12
HILTI EKSPANSIONSBOLT
Hulstørrelse Ø 12
Galvaniseret stål 25 stk / krt



S12
HILTI EKSPANSIONSBOLT
Hulstørrelse Ø 12
Galvaniseret stål 25 stk / krt



HILTI LIMANKRE
300 ML

Farver

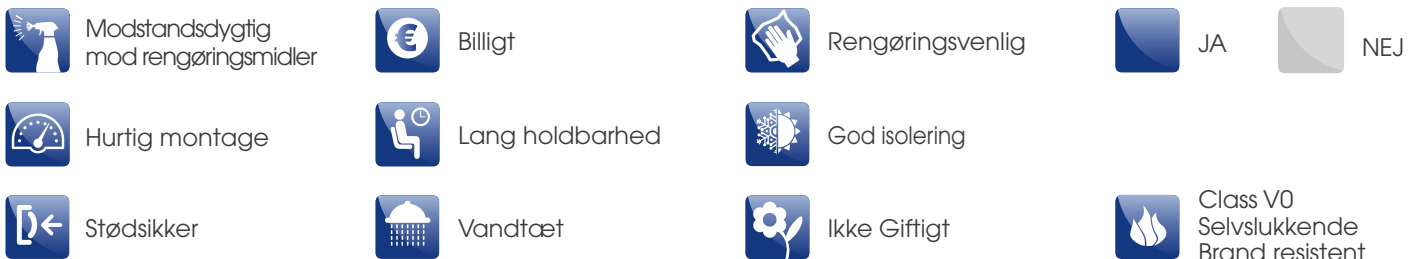

MPM forbeholder sig retten til at introducere nødvendige ændringer og forbedringer til deres produkter. Mindre afvigelser kan skyldes produktionsmetoden og anses ikke som fejl. Denne brochure må ikke reproducere.



VERDENS BEDSTE **LØSNINGER**,
DET PROFESSIONELLE VALG
KVALITET LAVET I ITALIEN



Global SafeZone ApS



REFERENCER



VORES INSTALLATION





EXCLUSIVE **AIRPORT LINE**



FLY HIGH MED
VORES VÆRN

ALWAYS **RESISTANT** / ALWAYS **FLEXIBLE**

Global SafeZone ApS

**KONTAKT VENLIGST
FOR MERE
INFORMATION!**



MPM states that:

Resistance refers to tests performed on the sample. The safety coefficient and consequent use of the product requires preliminary screening by a designer who will necessarily have to take account of the actual installation conditions. In any case, it is necessary to comply with the appropriate mounting regulations. The data refers to an intact product that can be affected by alterations from incorrect maintenance and old age, as well as the methods and characteristics of installation (with specific reference to floor-mounted products like the latter).

The weight, dimensions, colours and characteristics of the material refer to the sample and the conformity with the latter of the product supplied will be subject to normal production tolerance. The product may be affected by environmental installation conditions.

For safety purposes, installation requires screening by a qualified person as required by law. Instructions contained in catalogues, orders, transport documents or any other documentation showing the product characteristics, should not be considered suitable to compensate for any lack of design or technical testing required for installation of the product.

Images in the brochure are for advertising purposes only and do not in any way represent how the products should be used.

Impact forces indicated in the brochure, or in other documents, refer to laboratory tests and cannot take account for consequences determined by installation modes or peculiarities of the place where the products are installed.

The profiles provided by MPM are suitable for assembling the panels but this must be preceded by a project drawn up by a person holding the technical qualifications as required by and in compliance with the law; MPM declines any responsibility for the use of profiles in situations that have not been preceded by the checks now indicated.

The drawing in the brochure, or in other documentation provided by MPM, portrays a potential use of the product but cannot substitute the project and the technical checks by a qualified technician as required by law.

With specific reference to the T Suspension product, MPM declares that the product is suitable for assembling the surface (ceiling, floor, etc.) but its use must be preceded by adequate planning with specific evaluation of the weight of the panel and its intended use (and specifically the weight that said surface will have to bear in relation to the different uses).



MADE IN
ITALY



Global SafeZone ApS

H.C. Ørstedvej 2G
6100 Haderslev· Denmark

info@globalsafezone.dk
www.globalsafezone.dk